

BDM Interface

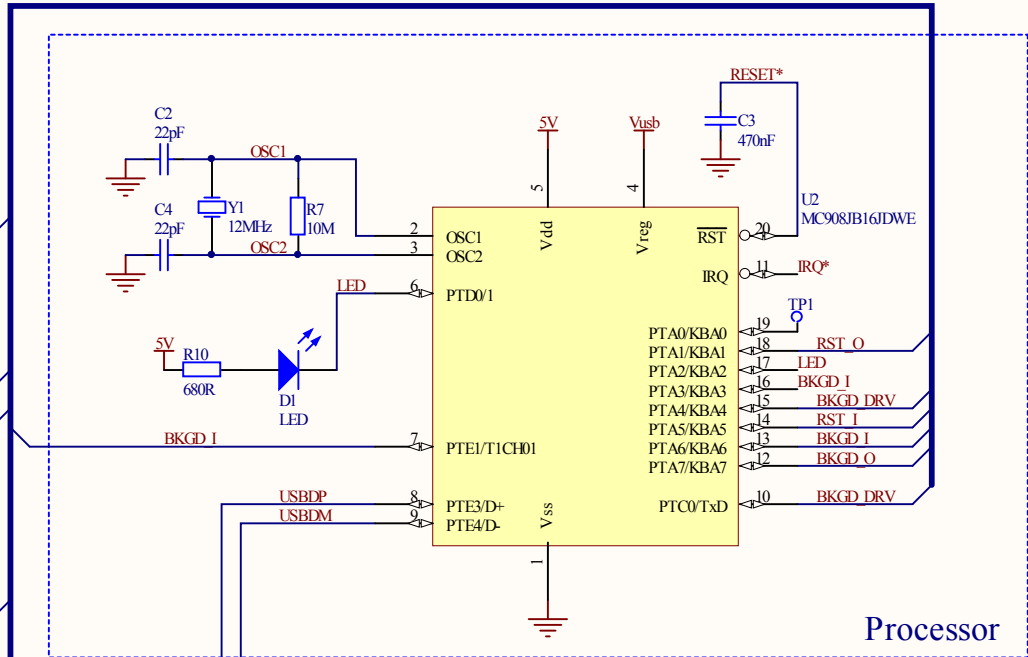

Processor

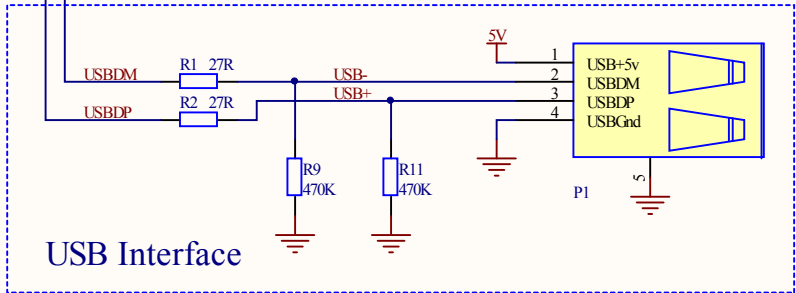

USB Interface

Notes:
 * This circuit has been adapted for the 20 pin version of the JB16 (JB16JDWE).
 * Z1 is a protection device and may be omitted.
 * Connection PTA2 and PTA3 are to make the PCB routing easier
 Revision 1.6
 * Added TP1, PUP on BDM_RST
 * Redone layout for above

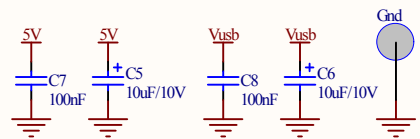

Title TBDML_SOIC20_JB16(Minimal)		
Size A4	Number	Revision 1.5
Date: 28/10/2009	Sheet of	
File: F:\USBDM.ATBDML_JB16_SOIC20.SchDoc	Drawn By:	

1mm plated slot

TBDML_JB16_SOIC20.PcbDoc

1mm slot

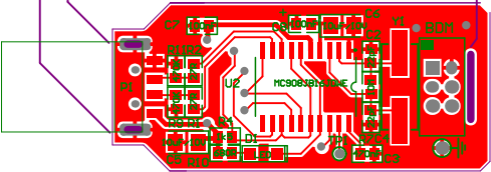

Board Outline this layer

Board Outline this layer

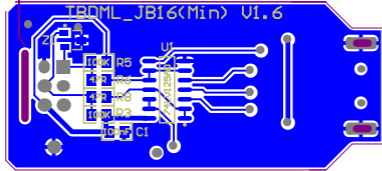

1mm plated slot

TBDML_JB16_201C50.PcbDoc

1mm slot

1mm plated slot

TBDML_JB16_SOIC20.PcbDoc

1mm slot

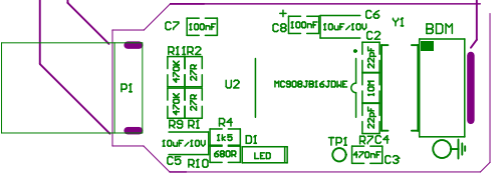

Board Outline this layer

Board Outline this layer

TBDML_JB16(Min) U1.6

Z1



U1
74LV125AD

100K R5
47R R6
47R R8
100K R3

100nF C1

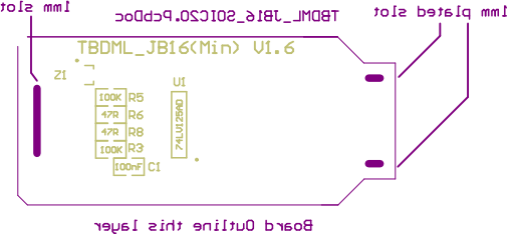

10mm plated slot

TBDML_JB16(Min) U1.6

10mm slot

Bill of Materials

TBDML_SOIC20_JB16(Minimal)

Source Data From: TBDML_JB16_SOIC20[Minimal].PRJPCB
 Project: TBDML_JB16_SOIC20[Minimal].PRJPCB
 Variant: None

Creation Date: 28/10/2009 5:59:16 PM
 Print Date: 28-Oct-09 5:59:18 PM

Footprint	Comment	Farnell PN	Digikey	Designator	Description	Quantity
CCNP2012-0805	100nF	8820120		C1, C7, C8	Capacitor SMT	3
CCNP2012-0805	22pF	1414676		C2, C4	Capacitor SMT	2
CCNP2012-0805	470nF	1288279		C3	Capacitor SMT	1
TC3528-1411	10uF/10V	9527745		C5, C6	Capacitor Polarized (SMT - Case A)	2
LED-SMT- Altronic 1206	LED	5790852		D1	LED	1
USB_TypeA M - SMT2	USB_CONNECTOR	1308875		P1	USB Connector	1
HDR2X3	Transition 3x2	1188909		P2	2x3 Transition or male header	1
CR2012-0805	27R	9334246		R1, R2	Resistor SMT	2
CR2012-0805	100K	9332405		R3, R5	Resistor SMT	2
CR2012-0805	1k5	1632464		R4	Resistor SMT	1
CR2012-0805	47R	1632490		R6, R8	Resistor SMT	2
CR2012-0805	10M	9236392		R7	Resistor SMT	1
CR2012-0805	470K	9333282		R9, R11	Resistor SMT	2
CR2012-0805	680R	9334785		R10	Resistor SMT	1
SO-14_L	74LV125AD	9592504	296-1674-5-ND	U1	Quad 3-state Buffer	1
SO-G20	MC908JB16JDWE	1703418		U2	Micro with USB (20p SOIC)	1
XTAL_SMT	12MHz	1652551		Y1	Crystal (Low profile SMT)	1
SOT23	PESD5V0S2UAT	8737738		Z1	Dual Unipolar Protection Device (5V)	1
						26

Approved	Notes